



KOREA HANWHA L&C CORP.

7-8F, Center1, Euljiro-5Gil, Jung-gu, Seoul, Korea 04539
Tel. +82-2-6364-7837 | Email. peterhong@hanwha.com
www.hanex-i.com

AMERICA HANWHA L&C USA LLC

2839 Paces Ferry Rd, Suite 1100, Atlanta, GA, USA 30339
Tel. +1-888-426-9421 | Email. info@hanwhasurfaces.com
www.hanexsolidsurfaces.com

INDIA HANWHA L&C INDIA OFFICE

Unit 1303, JMD Regent Square, Heritage City, Sector 25,
Gurugram, Haryana, India 122002
Tel. +91-124-431-7300 | Email. india01@hanwha.com

EUROPE HANWHA L&C EUROPE GMBH

Düsseldorfer Str. 13, Eschborn, Germany 65760
Tel. +49-6196-5869-020 | Email. info@hanwhasurfaces.eu
www.hanwhasurfaces.eu

CHINA HANWHA L&C TRADING (SHANGHAI) CO LTD

Unit 603, Mixc Mall A, Wuzhong Rd 1799, Minhang Dist, Shanghai, China 201103
Tel. +86-21-3252-2291 (320) | Email. sm.wang@hanwhahlcc.com
www.hlcc.cn

Designed in 2018/2019

Hanwha L&C

Hanex® Solid Surfaces

Hanex® Solid Surfaces



DESIGN BOOK
ENGINEERD TO INSPIRE



HANEX® products are non-porous and certified NSF51 for food preparation areas. Therefore, they can be applied in any application where sanitation is of utmost importance, such as kitchen worksurfaces, hospitals, playrooms or schools.



The unlimited design flexibility of HANEX® enables you to create a beautiful and durable aesthetic in any commercial setting, be it a hospital, bank, restaurant, hotel or office space. Commercial applications include : Office/hospitality and medical counters & worksurfaces, reception desks, bathroom worksurfaces and vanities, tabletops, food preparation areas, commercial fitouts including aesthetically seamless wall cladding, lift & foyer surrounds, lighting and more...

Hanex® Achieves The Following

Fire Certification EN13501-1b

This is the European Fire classification relating to all construction products, including products incorporated within building elements. Products are considered in relation to their end use application. HANEX® achieves EN13501-1b which is comparable to B5476 Class 0.

NSF51 Certification

This Standard is applicable to the materials and finishes used in the manufacture of food equipment (e.g., beverage dispenser, cutting board, work surfaces, etc).

Green guard Certification

Indoor Air Quality Certification ensures that products meet indoor air quality pollutant guide lines/standards.

Stain Resistance Report

HANEX® is an acrylic solid surface material product with a high level of alumina trihydrate content as the filler, an ingredient which provides superior resistance to stains and chemicals. However, exposure to harsh chemicals should be avoided. In case of surface contamination, quickly flush affected area with a domestic gritty cleaner and water. Sand if necessary, as a rule of thumb, surface damage may vary with the chemical strength and exposure time.

Scientific Certification Systems

These certificates relate to recycled chips in use in our material.

Applications





FEEL THE DIFFERENCE

SURFACES INSPIRED BY NATURE

Imagine a world where the solid surface powers your space. The surface's stratum look was inspired by the infinite beauty of nature.

Its multi-layered effect captures the depth and dimension of ground floors. Authentic features of stratum and travertine are achieved for the first time in solid surface.

STRATUM
ST-106 GRENCIO

STRATUM

Design Index

Stratum



ST-101 CLARA



ST-102 MARELINHO



ST-105 MORENO



ST-106 GRENCIO



ST-201 ROMANO

Design Index

Stratum



ST-202 WALNUT



ST-203 ALBERO



ST-204 MARRON



ST-301 OYSTER PEARL **NEW**



ST-101 CLARA | ST-105 MORENO



ST-103 NUBLADO



ST-101 CLARA



ST-106 GRENCIO



ST-105 MORENO



LOCATION SEOUL, KOREA
COLOR ST-203 ALBERO
PROJECT JTBC MY HOUSE APPEARED



ST-201 ROMANO



LOCATION TAIPEI, TAIWAN
 COLOR ST-201 ROMANO / ST-202 WALNUT
 PROJECT TAIPEI BUILD



LOCATION HOCHIMINH, VIETNAM
 COLOR ST-202 WALNUT
 PROJECT ANGELINUS COFFEE

BELLASSIMO
 BL-201 KASHMERE

Discover the diversity

In a world where everything moves so fast, Hanwha Surfaces makes the time to sweat the small stuff, pay attention to the details and understand what it takes to deliver something magical, something perfect. Delivering the industry's most comprehensive quartz and solid surfacing solutions – with unequalled consistency of color, texture and quality.

BELLASSIMO EPISODE II

Experience the greatness and grandeur in our new collection:

Inspired by patterns and colors of the elements in nature such as rock, wood and plant.

Hanex[®]
 Solid Surfaces

Design Index

Bellissimo Episode II



BL-201 KASHMERE



BL-204 SEAWAY



BL-205 SEDIMENTARY



BL-206 SLATE GREY



BL-209 MACASSAR

Bellissimo Episode II



BL-253 MOUNTAIN FROST **NEW**

Bellissimo



BL-014 STRATUS



BL-002 CELADON



BL-015 CHAMPAGNE



BL-003 PIETRA PANNA

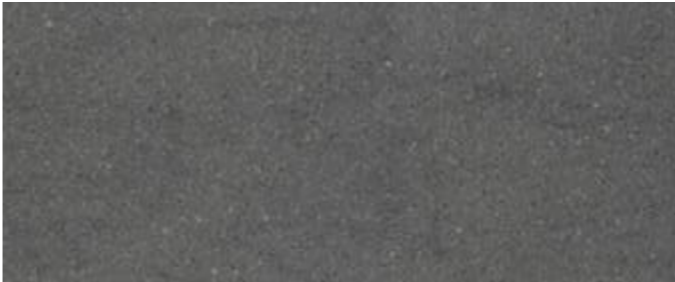

BL-016 CUMULUS



BL-206 SLATE GRAY
ST-102 MARELINHO



LOCATION NEW JERSEY, USA
COLOR BL-204 SEAWAY
PROJECT PRIVATE HOUSE, TRENTON



LOCATION SEOUL, KOREA
COLOR BL-201 KASHMERE
PROJECT CAFÉ ARINCO



LOCATION GWANGJU, KOREA
COLOR BL-209 MACASSAR
PROJECT KITCHEN SHOWROOM

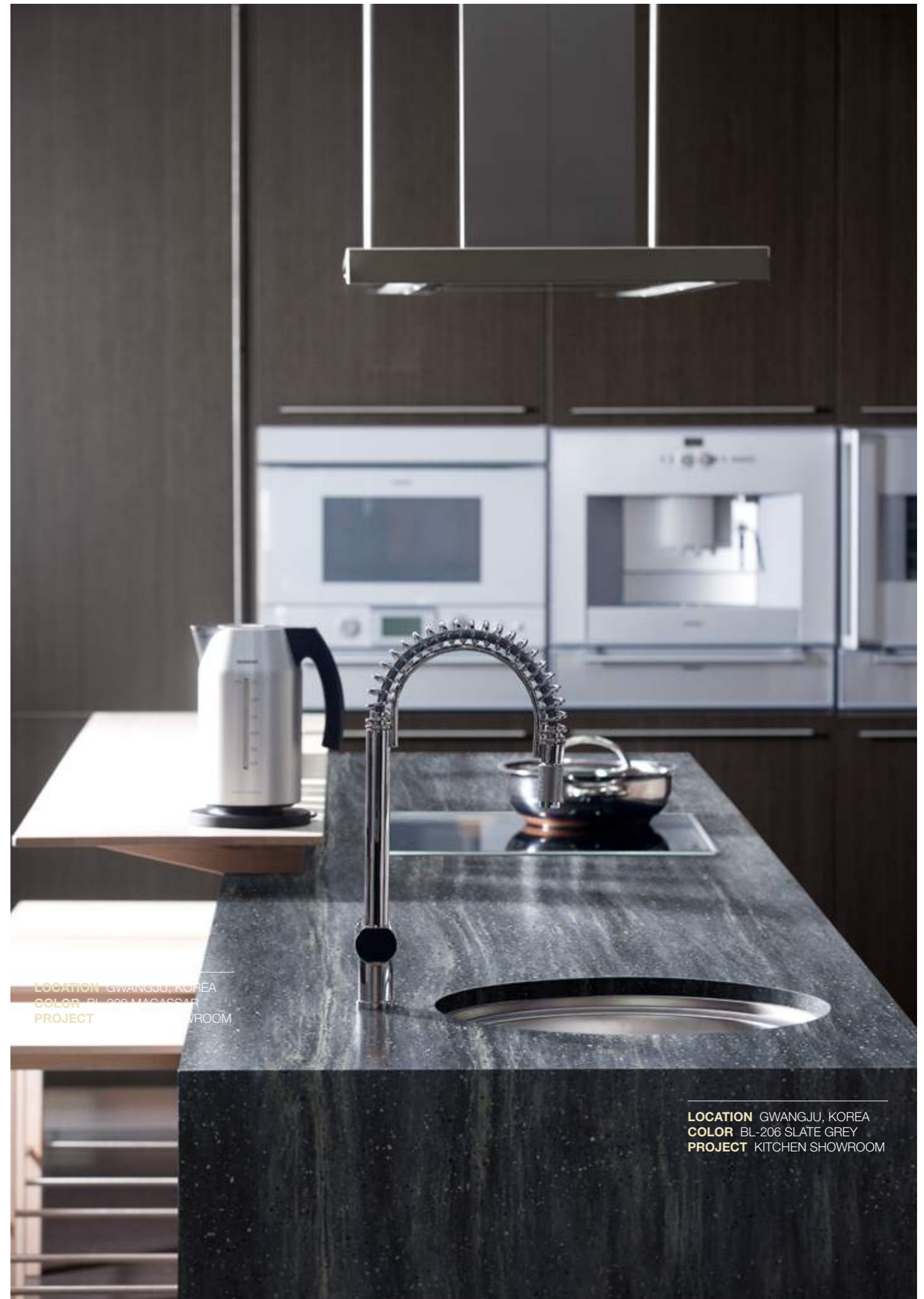

LOCATION GWANGJU, KOREA
COLOR BL-209 MACASSAR
PROJECT KITCHEN SHOWROOM

LOCATION GWANGJU, KOREA
COLOR BL-206 SLATE GREY
PROJECT KITCHEN SHOWROOM

LOCATION SEOUL, KOREA
COLOR BL-205 SEDIMENTARY
PROJECT CAFÉ ARINCO



LOCATION JEJU ISLAND, KOREA
COLOR BL-201 KASHMERE
PROJECT SEOHAN INDUSTRY



LOCATION SEOUL, KOREA
COLOR BL-209 MACASSAR
PROJECT STUDIO SEOUL



PUBLIC PLACE

COMMERCIAL

LOCATION FRANKFURT, GERMANY
COLOR S-008 N-WHITE
PROJECT ASOS SHOP



LOCATION SEOUL, KOREA
COLOR S-008 N-WHITE
PROJECT GALLERIA DEPT. STORE



LOCATION HANAM, KOREA
COLOR S-008 N-WHITE
PROJECT LOCCITANE STORE

LOCATION BANGKOK, THAILAND
COLOR S-008 N-WHITE
PROJECT NOKIA FLAGSHIP STORE





LOCATION SEOUL, KOREA
 COLOR S-008 N-WHITE
 PROJECT COEX MALL



LOCATION SEOUL, KOREA
 COLOR S-008 N-WHITE
 PROJECT TOYOTA AT SEOUL MOTOR SHOW



LOCATION BANGKOK, THAILAND
 COLOR S-008 N-WHITE
 PROJECT ZPELL DEPT. STORE



LOCATION HANAM, KOREA
 COLOR S-008 N-WHITE
 PROJECT LAMY STORE



RESTAURANT

COMMERCIAL

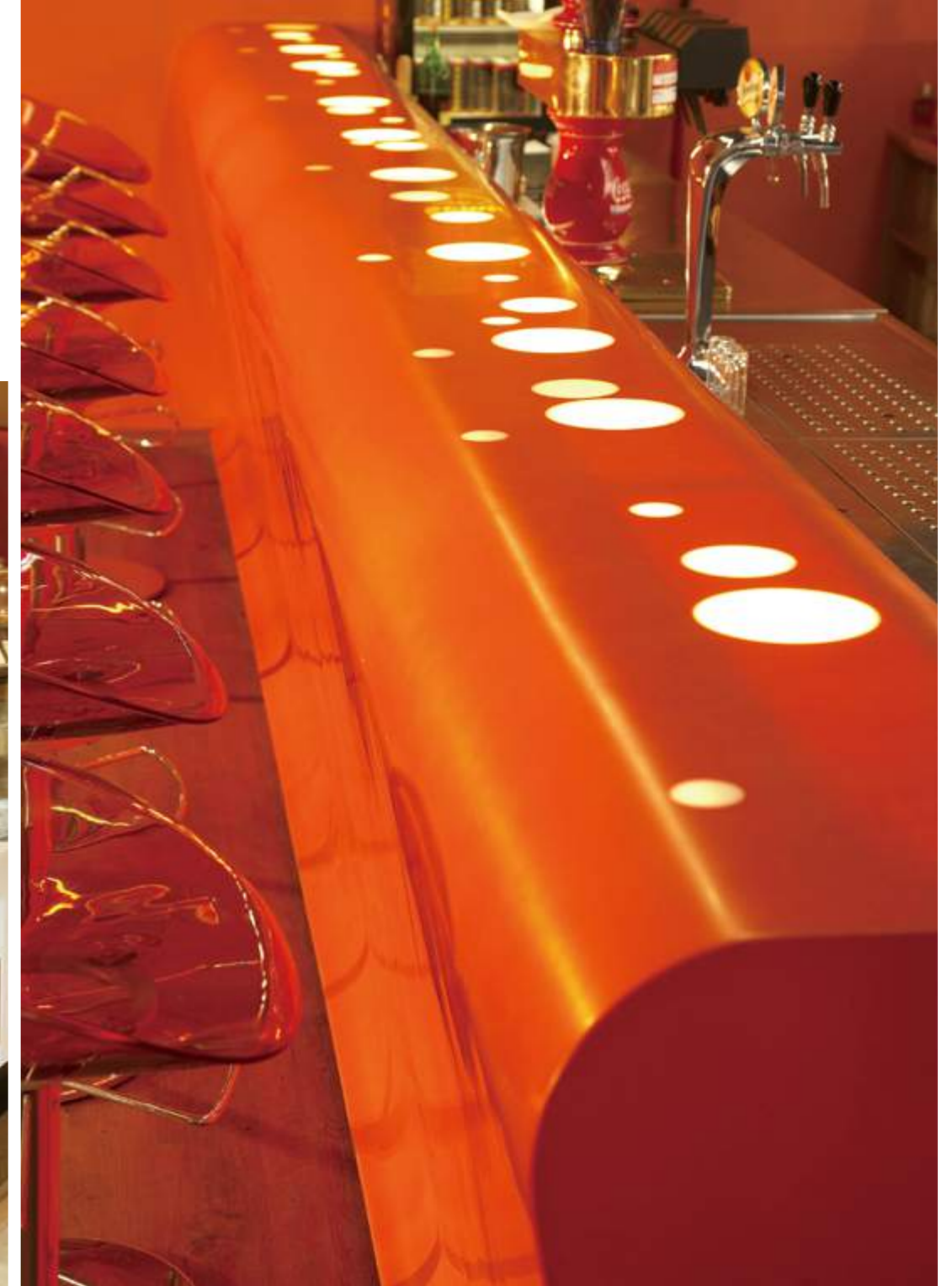

LOCATION BANGKOK, THAILAND
COLOR S-008 N-WHITE
PROJECT SOMERSET THAILAND

LOCATION HOCHIMINH, VIETNAM
COLOR S-008 N-WHITE
PROJECT LOTTERIA



LOCATION PRAGUE,
CZECH REPUBLIC
COLOR S-008 N-WHITE
PROJECT BAR ORANZOZY

OFFICE

COMMERCIAL



LOCATION KINGSTON, CANADA
COLOR C-001 CUBIC WHITE
PROJECT HDR DESIGN



LOCATION ISTANBUL, TURKEY
COLOR S-008 N-WHITE
PROJECT GENMAR OFFICE



LOCATION HOCHIMINH, VIETNAM
COLOR S-008 N-WHITE
PROJECT COTECONS



HOSPITAL

COMMERCIAL



LOCATION SEOUL, KOREA
COLOR S-008 N-WHITE
PROJECT GANGNAM PUBLIC CONVALESCENT HOSPITAL

LOCATION SEOUL, KOREA
COLOR S-008 N-WHITE
PROJECT PRIVATE DENTAL CLINIC



LOCATION ISTANBUL, TURKEY
COLOR S-008 N-WHITE
PROJECT ACIBADEM



LOCATION SEOUL, KOREA
COLOR S-008 N-WHITE
PROJECT GANGNAM PUBLIC
CONVALESCENT HOSPITAL

WALL CLADDING

COMMERCIAL

LOCATION SHENZHEN, CHINA
COLOR S-008 N-WHITE
PROJECT TCL CORPORATION



LOCATION BEIJING, CHINA
COLOR S-008 N-WHITE
PROJECT TERMINUS





LOCATION GUANGZHOU, CHINA
 COLOR S-008 N-WHITE
 PROJECT SONG CLUB



LOCATION SEOUL, KOREA
 COLOR S-008 N-WHITE
 PROJECT GALLERY Q



LOCATION QINGDAO, CHINA
 COLOR S-008 N-WHITE
 PROJECT AMERICAN PARK

LOCATION DUBAI, UAE
 COLOR S-008 N-WHITE
 PROJECT HUES BOUTIQUE HOTEL



RECREATIONAL VEHICLES

COMMERCIAL



LOCATION KENTUCKY, USA
COLOR ST-105 MORENO
PROJECT RV SHOW, LOUISVILLE



LOCATION KENTUCKY, USA
COLOR BL-253 MOUNTAIN FROST
PROJECT RV SHOW, LOUISVILLE



LOCATION GYEONGGI, KOREA
COLOR S-019 BROWN FEVER
PROJECT DOOSUNG CAMPER VAN



LOCATION KENTUCKY, USA
COLOR ST-201 ROMANO
PROJECT RV SHOW, LOUISVILLE

KITCHEN

RESIDENTIAL



LOCATION GYEONGJU, KOREA
COLOR T-201 FETA CHEESE
PROJECT SG MISOZIUM CONDOMINIUM



LOCATION TAIPEI, TAIWAN
COLOR GAM-001 AFTERSNOW
PROJECT TEAM7 FURNITURE

LOCATION SEOUL, KOREA
COLOR M-007 M-BLACK
PROJECT LET ME HOME





LOCATION TAIPEI, TAIWAN
 COLOR GAM-001 AFTERSNOW
 PROJECT TEAM7 FURNITURE



LOCATION SEOUL, KOREA
 COLOR C-001 CUBIC WHITE
 PROJECT LOTTE CASTLE



LOCATION SEOUL, KOREA
 COLOR ST-201 CLARA
 PROJECT PRIVATE HOUSE



Location SEOUL, KOREA
 Color B-040 COPPER BLACK
 Project QCINE CELEB SPONSORSHIP

BATH

RESIDENTIAL



LOCATION NSW, AUSTRALIA
COLOR S-008 N-WHITE
PROJECT SCF INTERIORS, WAREEMBA



LOCATION MOSCOW, RUSSIA
COLOR S-008 N-WHITE
PROJECT CITY HOTEL



LOCATION BEIJING, CHINA
COLOR S-008 N-WHITE
PROJECT OPERA MALL



LOCATION SINGAPORE, SINGAPORE
COLOR C-001 CUBIC WHITE
PROJECT MINTON CONDOMINIUM

LOCATION SEOUL, KOREA
COLOR ST-101 CLARA
PROJECT RAUM EXHIBITION



LOCATION SEOUL, KOREA
COLOR S-008 N-WHITE
PROJECT HANWHA L&C SHOWROOM

Design Index

Solo



S-002 WHITE
S-008 N-WHITE
S-014 AQUEOUS
S-025 CHERRY BLOSSOM **NEW**

S-004 IVORY
S-006 GREY
S-022 STEEL **NEW**
S-019 BROWN FEVER

T Translucent

Magic



M-006 N-YELLOW
M-005 N-ORANGE
M-003 M-RED
M-012 MARINE BLUE **NEW**

M-014 GREY ASH **NEW**
M-007 M-BLACK

Duo



D-024 SILVER WHITE
D-025 LIGHT SAND
D-001 SILVER STONE
D-101 NANTUCKET **NEW**
D-102 SEASHORE **NEW**

D-003 GOLD BROWN
D-009 SAND BANK
D-012 LIGHT BROWN
D-027 MARRONNIER
D-007 MIST

D-105 RHAPSODY **NEW**
D-112 GRAVITY **NEW**
D-015 BLACK HILL
D-028 BLACK BEAT



Pearl



P-004 SOLARIS
P-002 METAL GREY
P-005 NIGHT GLEAM
P-010 GLUTTONY **NEW**

Design Index

Trio



T-021 PURE ARCTIC T-089 VOCALISE T-050 ICE QUEEN T-201 FETA CHEESE T-204 SILK VIVIAN **NEW**

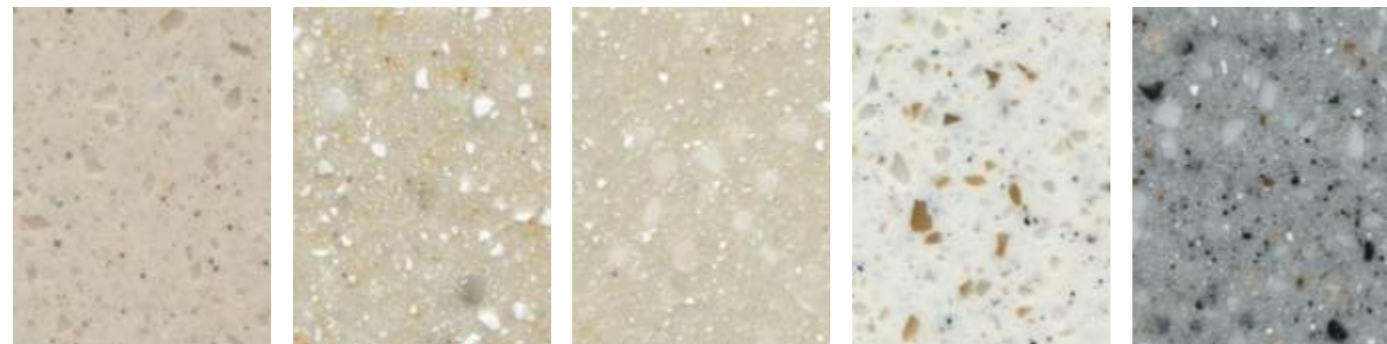

T-209 GROVIZU T-102 HIDDEN GLEN **NEW** T-012 H-ELEGANCE T-500 TOFFEE CRUNCH **NEW** T-008 H-CLOUDY

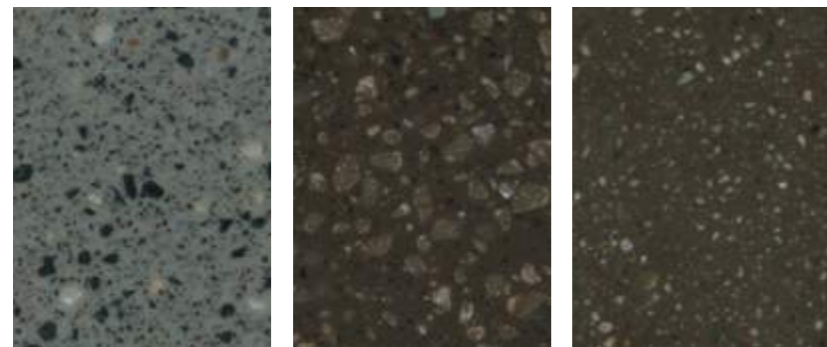

T-042 H-GRAVEL T-104 COCOA VINE **NEW** T-025 CHESTNUT



Cubic

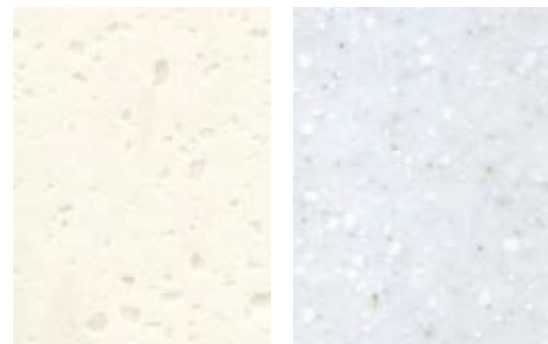

C-001 CUBIC WHITE C-004 CUBIC TRANSLANC



Therapy Collection

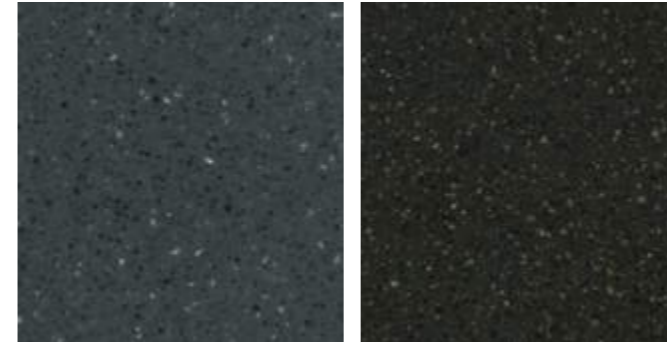

RE-05 YURI GREY RE-06 CACAO UMBER

'THERAPY' is the eco-friendly collection which provides the organic and natural look. These products are manufactured with recycled resources so that you could heal the environment with this 'THERAPY' series.

Galleria

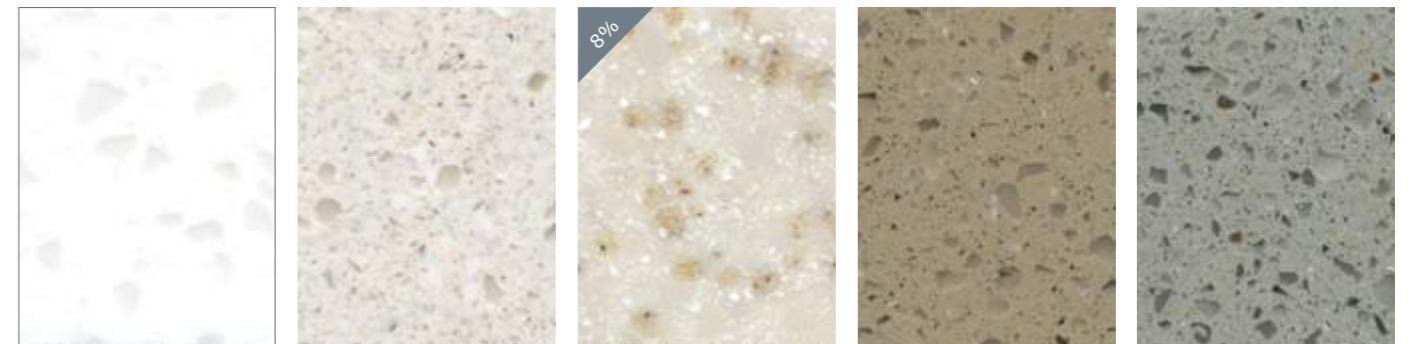

GAM-001 AFTERSNOW GAD-001 ATHENA **NEW** GAM-004 SAND FLOWER GAD-011 XENON **NEW** GAD-007 JUNO **NEW**

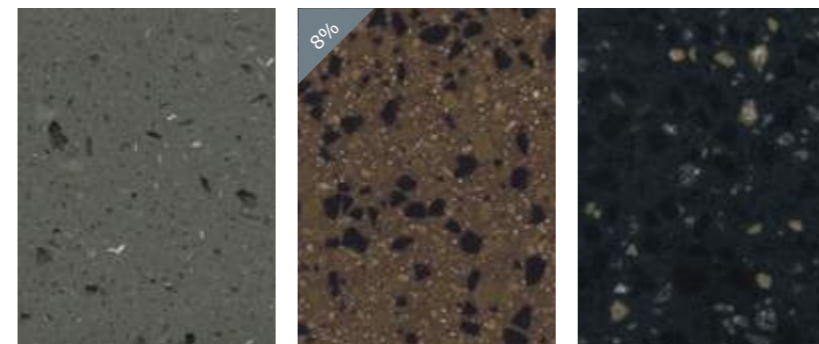

GAD-015 PERSEUS **NEW** GAR-006 DESERT CASTLE GAR-010 BLACK SPOT



Design Index

Glittering

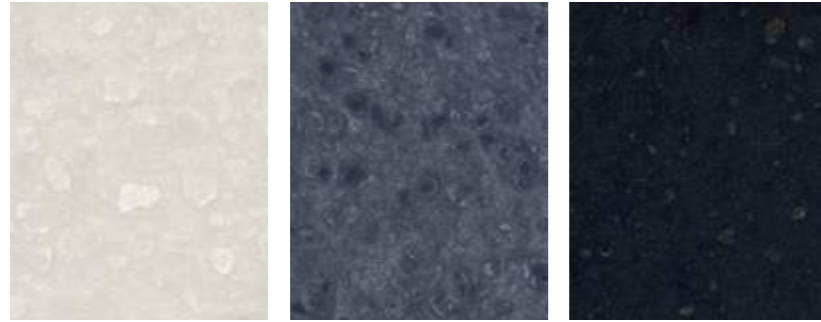

GL-001 PEGASUS

GL-003 LIBRA

GL-006 CYGNUS

All dark décors are prone to show scratches, dust, haziness and ordinary wear and tear more easily than lighter textured décors. Therefore, these décors are not recommended for use in residential and commercial applications that will be subject to heavy use.

Nativo Collection



NA-01 BLANDO

NA-06 MONTES

The new and premium collection 'NATIVO' resembles distinguished and premium look of nature. The unique atypical chips and tone-on-tone colors in 'NATIVO' create the natural and wild look which solid surfaces never had before.

Brionne



B-012 OSLO WHITE

B-031 HELSINKI

B-001 IVORY ESSENCE

B-004 BASILICA

B-039 WILD FIRE



B-040 COPPER BLACK

*Colors may vary from actual production

One Inspirational Surface

Hanex® solid surfaces can be fabricated and installed in almost any residential or commercial application with inconspicuous seams. Rich colours and textures. Superior function and form. Discover the many unique benefits of Hanex®. The only limitation of Hanex® is your imagination.

- Easy to fabricate designs envisioned by designers or architects
- Highly durable
- Maintains its colour and shape
- Resistant to heat, mould, pollutants and bacteria
- Renewable, repairable & environmentally friendly
- Easy to care for & maintain – scratch & stain resistant
- Extensive colour range
- 10 Years limited warranty
- Endless design possibilities
- Hanex® achieves the highest for classification – en13501-1b



BL-206 SLATE GREY



BL-207 BORDEUX

Single Sinks

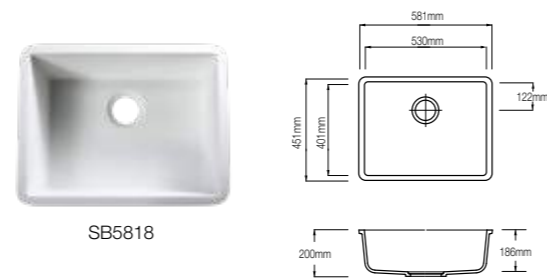
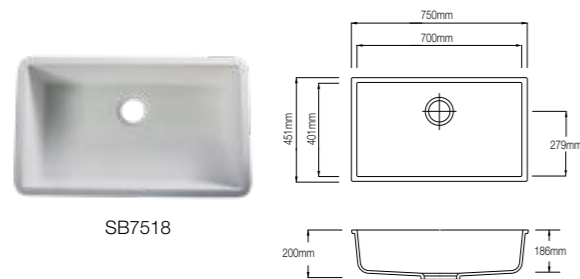
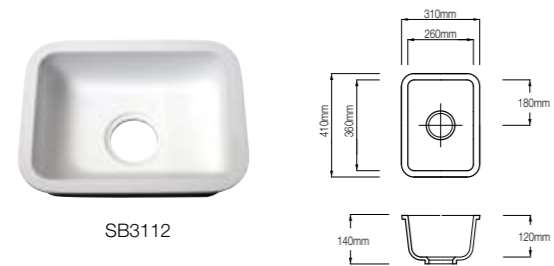
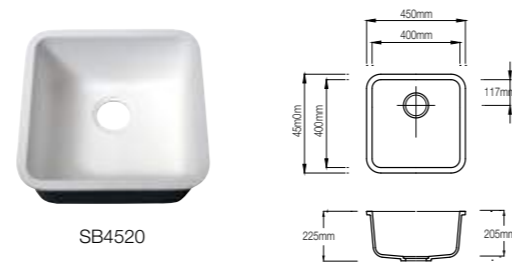
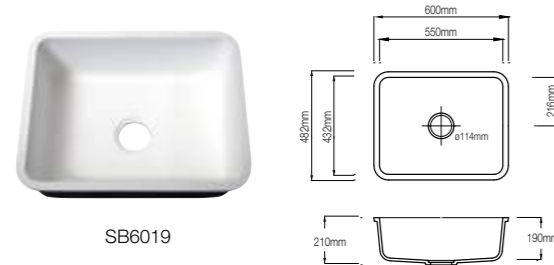
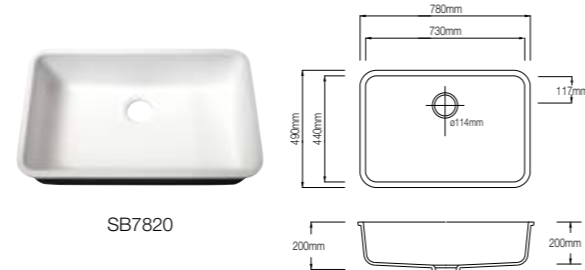
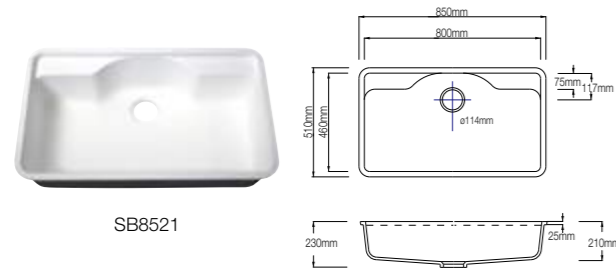

Double Sinks

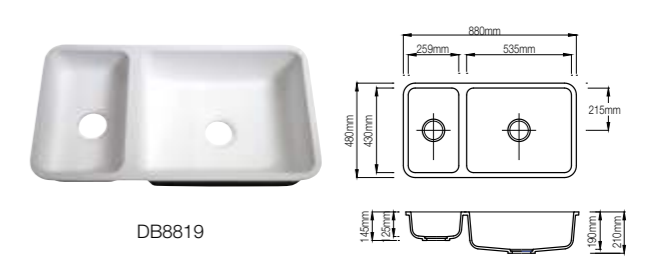
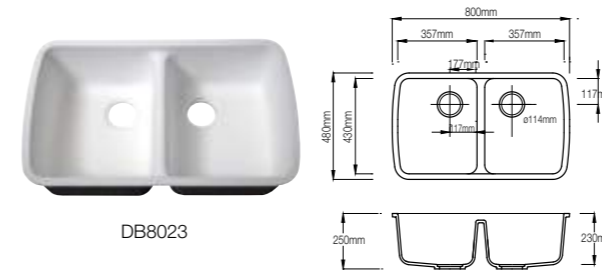

Bowls

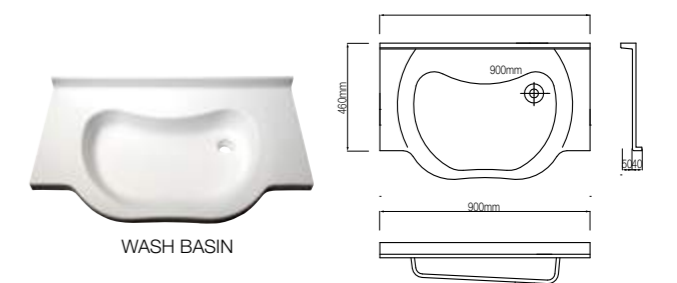
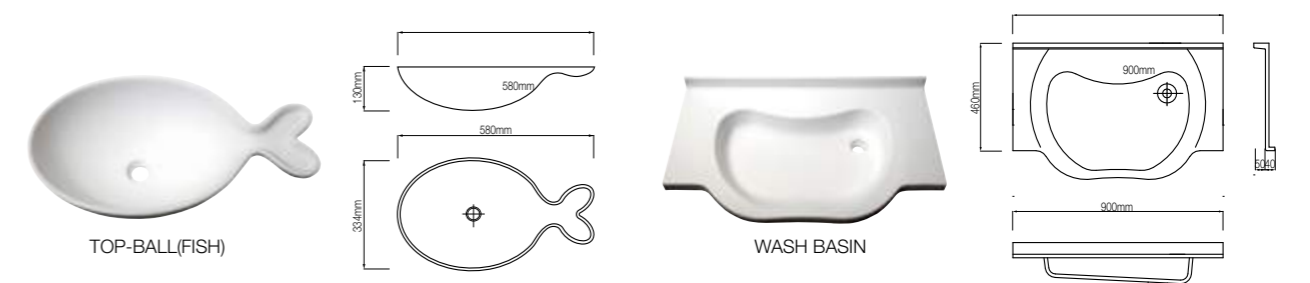
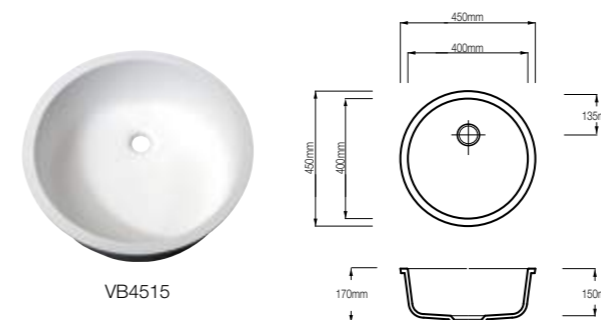
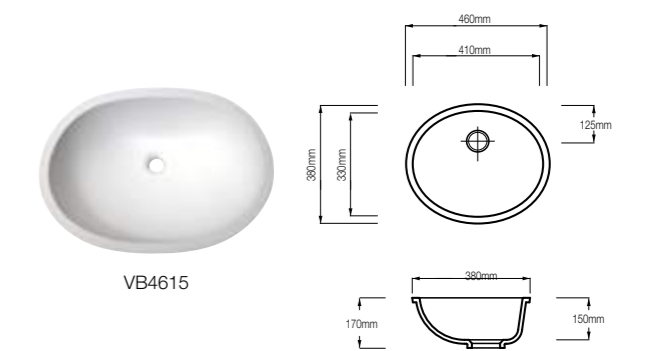
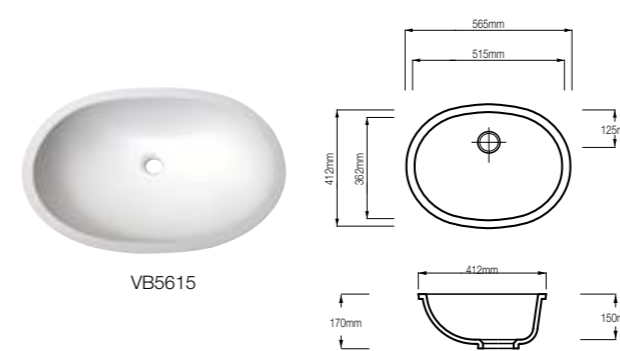

Colours available

S-008 N-WHITE & S-004 IVORY other colors upon request, please contact your local Hanex Distributor All casted sinks are covered by 10 year manufacturers warranty.

Features

- 100% acrylic Sinks & Bowls
- Excellent quality and design
- Available to make the customized designs
- Good color matching with solid surface
- Available in even small quantity(HANEX model)

Available in Solo category with matching solid surface or stainless steel base. All fabricated sinks are covered by 10 year manufacturers warranty. Delivery lead-times will apply as these sinks are manufactured to order.

Hanex®

Solid Surfaces

STRATUM



- Hanex
- Wood
- Laminate

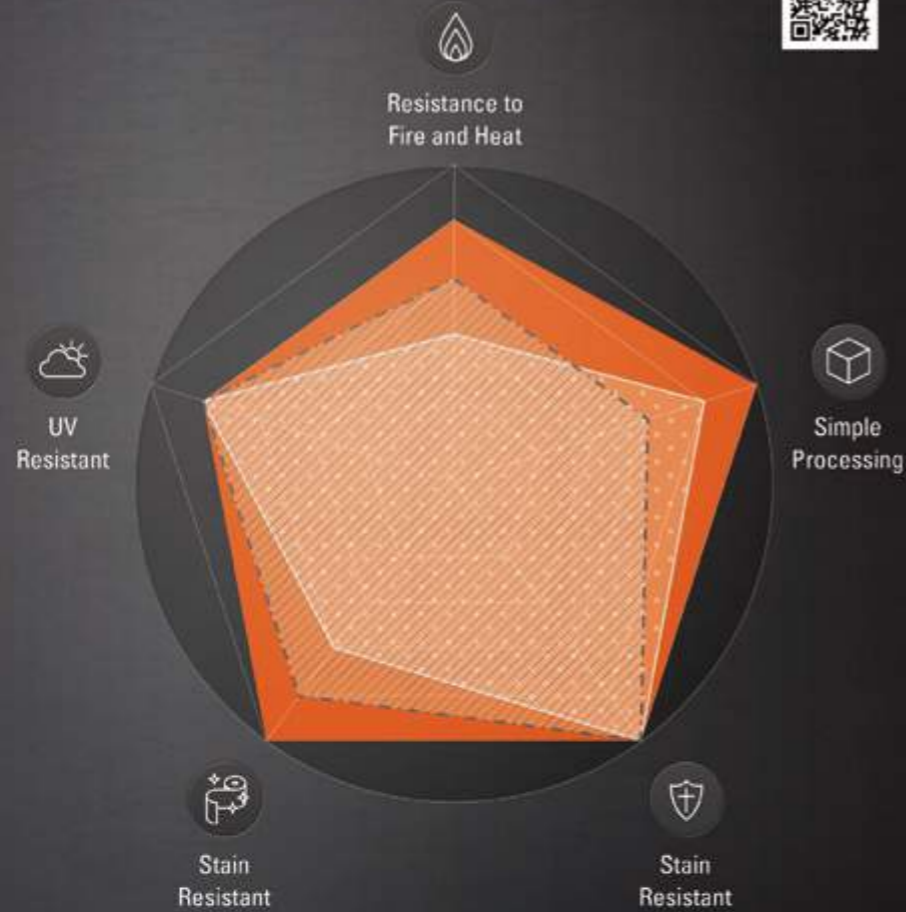

Hanex is the ideal material for countertops for both residential and commercial buildings.

Standard Size

Hanex has various colors and patterns, and is made of the same materials both inside and outside. It can compensate the disadvantages of laminate and coating. It can also be processed in limitless forms in which is not possible with laminate and natural stone.

* Other size is available upon special order

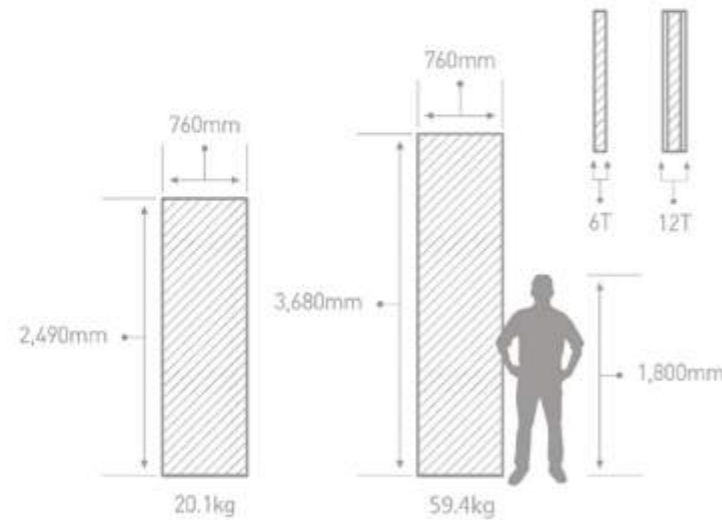

Certification

Hanex is highly regarded in the environment-friendly materials market with various environmental related certifications such as NSF, Greenguard, and SCS.



Hanex® Material Safety Data Sheet

Chemical Product And Company Identification

Material Identification

HANEX (HANEX is a registered trademark of HANWHA L&C CORP.)

Company Identification Manufacturer

HANWHA LIVING & CREATIVE CORP.

7F Center1, 26, Eulji-ro, 5-Gil, Jung-gu, Seoul 100-210, Korea

Contact Details For Information

HANWHA LIVING & CREATIVE CORP.

7F Center1, 26, Eulji-ro, 5-Gil, Jung-gu, Seoul 100-210, Korea

Ph: +82 2 6364 7817 Fax: +82 2 6367 7809

Composition And Information On Ingredients

Component	CAS	%
Polymethylmethacrylate	8011-14-7	>30
Alumina Trihydrate	21645-51-2	<70
Methylmethacrylate (Degradation Product)	80-62-6	<1

Heated above 300 dCe,g " HANEX" can release

Fire-Fighting Measures And Explosion Hazard

Flammable Properties

"HANEX" can be combusted only with difficulty.

Hazardous gases/vapor produced in fire are carbon monoxide, methyl methacrylate, aldehydes

Extinguishing Media

Water, Dry chemical, CO2

Fire Fighting Instructions

Keep personnel removed and upwind of fire.

Wear self-contained breathing apparatus.

Accidental Release Measures

Safeguard (Personnel)

NOTE : Review FIRE FIGHTING MEASURES and HANDLING (PERSONNEL) sections before proceeding with clean-up.

Use appropriate PERSONAL PROTECTIVE during clean up.

Spill Clean Up

Recover undamaged and minimally contaminated material for reuse and reclamation.

Handling And Storage

Handling (Personnel)

Avoid breathing dust.

Avoid breathing fumes generated during sawing, routing or drilling.

Handling (Physical Aspects)

Avoid dust generation.

Storage

Store in a cool place

Hanex® Specification

Exposure Controls And Personal Protection

Engineering Controls (Ventilation)

Use ventilation that is adequate to keep employee exposure to air borne concentration below exposure limits.

Personal Protection

Protective equipment: EYE/FACE PROTECTION

Wear safety glasses during operations such as sawing, sanding, drilling or routing.

Toxicological Information

Skin / Eye Irritant Polymethylmethacrylate

The compound is not a skin or eye irritant and is not a skin sensitizer in animals. Single or repeated ingestion produced mild degenerative changes of liver and kidney.

Methyl Methacrylate

The compound is a skin irritant, is a moderate eye irritant, and is a skin sensitizer in animals.

Alumina Trihydrateyleate

The compound is untested for skin and eye irritant, and is untested for animal sensitization.

Acute Toxicity (LC50)

POLYMETHYL METHACRYLATE

>2MG/1, 4hr LC50(Inhalation/Rat)

METHYL METHACRYLATE

7093PPM/4hr LC50(Inhalation/Rat)

Acute Toxicity (LC50)

POLYMETHYL METHACRYLATE

>2000mg/kg, 4hr LD50(Oral/Cat)

METHYL METHACRYLATE

7900PPM/4hr LD50(Oral/Cat)

Ecological Information

BIODEGRADATION

No information is available

BIOACCUMULTION

No information is available

AQUATIC TOXICITY

No information is available

Disposal Considerations

Dispose in accordance with federal, state and local regulation.

The owner of the material is responsible for proper waste disposal.

Other Information

The data in this Material Safety Data Sheet relates only to the specific material designated herein and does not relate to use in combination with any other material or in any process.

Responsibility for MSDS : "HANEX" products

Technical Specification

Sample: Scagliola(HANEX) D

Test Item	Unit	Sample	Result	Test Method
Specific Gravity((23/23) °C)	-	-	1.756	ASTM D792-08(Method A)
Rockwell Hardness(HRM)	-	-	90	ASTM D785-08(Procedure A)
Tensile Strength	MPa	-	43.8	ASTM D638-10(*)
Tensile Modulus of Elasticity	GPa	-	12.6	ASTM D638-10(*)
Flexural Strength	MPa	-	58.8	ASTM D790-10(**)
Flexural Modulus of Elasticity	GPa	-	10.6	ASTM D790-10(**)
Izod Impact Strength	J/m	-	16	ASTM D256-10(Method A)
Water Absorption(24h Immersion)	%	-	0.036	ASTM D570-98(2010)e1
Density(23 °C)	g/cm ³	-	1.751	ASTM D792-08(Method A)
Heat Resistance Test	-	-	No Defects	JIS K 6902 : 2008
Hot Water Resistance Test	-	-	No Defects	JIS K 6902 : 2008
Deflection Temperature Under(1.82 Mpa)	°C	-	115	ASTM D648-07(Method B)
Thermal Expansion	1/ °C	-	3.93×10 ⁻⁵	JIS K 6911 : 2006

*Specimen: Type I, Speed of Testing: 5 mm/min(Modulus: 1 mm/min)

*Speed of Testing: 5.2 mm/min, Support Span: 190 mm

USAGE: QUALITY CONTROL